

BLUMOTION

inside



METABOX with BLUMOTION

New variation on proven Technology



BLUMOTION
inside



Motion is
being optimised

The METABOX programme





A High quality programme with minimum components

The silent and effortless closing of
furniture – This is becoming appreciated
more and more by people in their homes.

Now this BLUMOTION comfort is also
available for METABOX. Thus you can
offer your customers a high-quality and,
at the same time, economical system
with only a few components.

BLUMOTION closing comfort

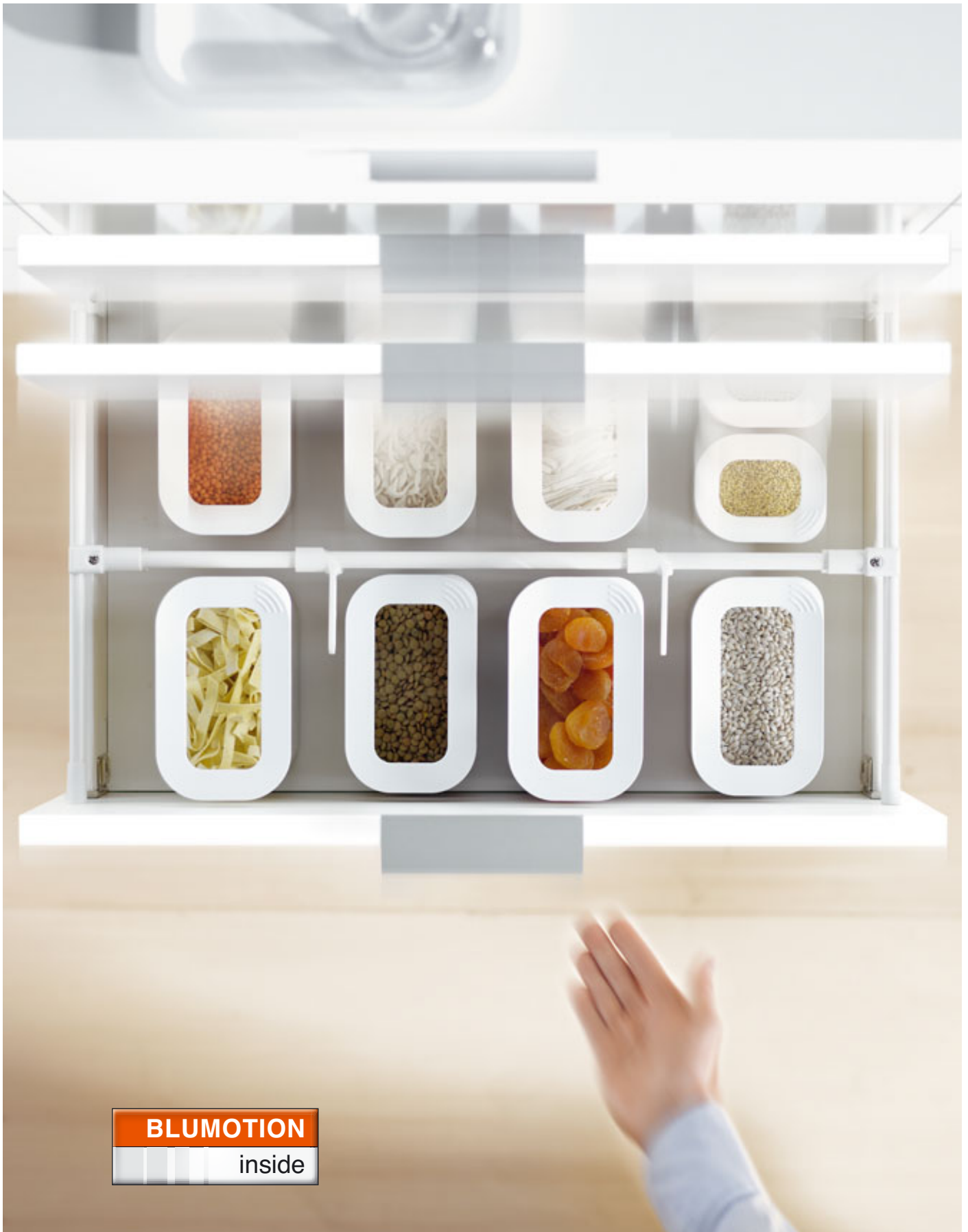

BLUMOTION
inside

BLUMOTION brings **silent** and **effortless closing action** to METABOX



Now you can also use the tried and tested BLUMOTION function with METABOX: Ensuring that drawers and pull-outs always close silently and effortlessly – regardless of the closing force or the weight of storage items.

BLUMOTION for METABOX has been specially designed for single extensions with a total load of 25 kg – for smooth running and excellent closing action. Despite the high dampening power, pull-outs and drawers open very easily.

Especially practical and economical: You only need one BLUMOTION for most applications.

METABOX BLUMOTION



A perfect team

BLUMOTION and the integrated BLUMATIC work as perfect partners. They ensure silent and effortless running action as well as a secure close. BLUMOTION is compatible with all METABOX single extensions for heights N, M, K, H up to a total load of 25 kg.



	BLUMOTION	Part No.
	BLUMOTION with latch in cream (CW), recommended for drawer sides in cream	Z70.0320
	BLUMOTION with latch in white (W), recommended for drawer sides in white	Z70.0320
	BLUMOTION with latch in white grey (WGR), recommended for drawer sides in white aluminium	Z70.0320
	The BLUMOTION housing is always white grey.	

METABOX quality



Everyday kitchen activities

define our demand for quality

Opening and closing 100.000 times:
This is only one of the many tests that METABOX and BLUMOTION must endure in our testing labs. In the end, our products must be ready for the varied demands required in the modern kitchen and provide joy for the lifetime of the furniture.



METABOX stands for excellent runner action and high stability – even under heavy loads. You can also see quality in the details: Each METABOX has an integral pull-out stop which is also used when a static position is required – e.g. when using a bread slicer.



The METABOX runner

Excellent runner action and reliable stability

Low-friction nylon rollers help to ensure this excellent runner action. METABOX has built in 2mm tolerance compensation for drawer assembly. This ensures that METABOX always runs easily and smoothly.

A selection of high-strength materials and precise assembly ensure the best stability values – all that and a max. dynamic carrying capacity of 25 kg.



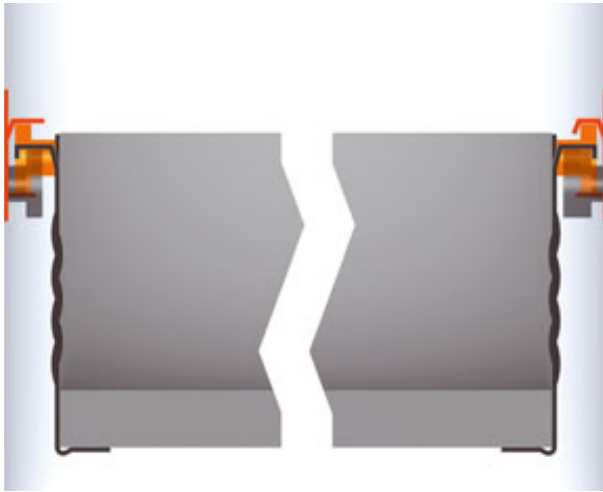

Tolerance compensation only takes place on the left cabinet side. On the right side, the drawer or pull-out is guided on the side in a stable manner.



METABOX drawers and pull-outs are very easy to insert and remove. This makes assembly easy and simplifies drawer cleaning.



The METABOX design



Many opportunities with a universal design



Drawer side height N (54 mm)



Drawer side height M (86 mm)



Drawer side height K (118 mm)



Drawer side height H (150 mm)

Although the METABOX programme only comprises a few components, it gives you so much freedom: Thanks to different cabinet widths, drawer side heights and lengths, you can implement various applications. When designing the high fronted pull-out, you can choose between a gallery or single walled BOXSIDE. Even the colour choices provide you – and your customers – with several options.

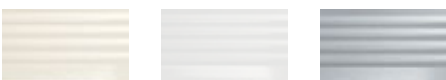

Drawer sides come standard in cream (RAL 9001); white and grey (RAL 9006) are available upon request.



METABOX is available for the following ...

- Drawer side heights: N (54 mm), M (86 mm), K (118 mm), H (150 mm)
- Nominal lengths: 270 to 550 mm

The METABOX drawer

Great for use anywhere

Whether in the kitchen, living room or hall: METABOX is suitable for all living areas and has already proven itself in offices and showrooms. METABOX offers the right solution for any installation situation due to its flexibility in width, height and depth.





The METABOX high fronted pull-out



Heavy storage items are accommodated by the METABOX high fronted pull-out – It is designed for a max. carrying capacity of 25 kg.

You can design the drawer to your own taste: With a single walled BOXSIDE, gallery or double gallery. And for organisation and overview, you can use ORGA-LINE alongside and cross dividers.

Offers storage space
and high durability



i

METABOX for high fronted pull-outs is available for the following ...

- Back heights: B (167 mm), C (207 mm), D (231 mm)
- Nominal lengths: 350 to 550 mm

The METABOX inner drawer



For flexibility behind the furniture front

You can plan METABOX inner drawers using all drawer side heights providing customised solutions. Because METABOX is robust, the programme is also well-suited for use in showrooms.



METABOX for inner drawers is available for the following ...

- Drawer side heights: N (54 mm), M (86 mm), K (118 mm), H (150 mm)
- Nominal lengths: 270 to 550 mm

METABOX assembly

A High quality programme

which is easily assembled



The few components of the METABOX programme can be assembled in no time: You can use the classic screw-on assembly as well as the tool-free Blum CLIP and INSERTA assembly methods.

You only need to attach the BLUMOTION unit to the left cabinet side. The drillings for all parts use the 32 mm drilling system.

And the front can be adjusted in 3 dimensions to easily ensure a harmonious gap design.



One-sided assembly is enough: Only one BLUMOTION unit is required for most applications



Activating the BLUMOTION function: The latch on the base of the drawer.

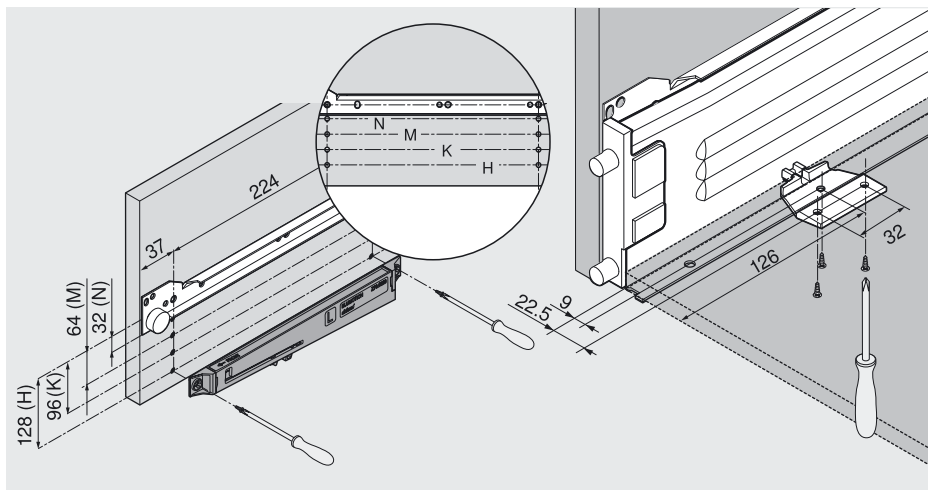

System 32: BLUMOTION unit assembly uses a 32 mm drilling system.



Side adjustment range: +/- 1.5 mm



Height adjustment range: +/- 1.8 mm





The high-fronted pull-out has tool-free tilt adjustment via the gallery.

METABOX accessories



Everything neatly arranged – This is provided by the longside and cross dividers of our ORGA-LINE inner dividing system (for METABOX high fronted pull-outs with BOXSIDE, single or double gallery)

Spacer	Spacing	Part No.	POSISTOP	Front gap	Part No.
	4 mm	320M0048		1.5 mm	298.3210.01
	8 mm	320M0088		3 mm	298.3230.01
	8 mm with dowel Ø 5 mm	320M0188			
<p>Screw-on spacers bridge the door protrusion for inner drawers.</p>			<p>POSISTOP dampens the stop in runner systems and can also be used symmetrically.</p>		

The right solution for all situations

Whether in the kitchen, living rooms or office:
You can offer your customers special solutions for
different applications with these versatile accessories.



Child safety latch

295.5500

Whether it's medicine or cleaning materials – everything is stored safely with the child safety latch.



METAFILE

ZRM.5500

Create organisation: The METAFILE file drawer for the METABOX high fronted pull-out.



Pull-out stop

320M0009.01

Prevents accidental removal: The pull-out stop.



Contoured profile

ZSD.1200S

The base profile forms a flexible lip between the base and drawer side. This makes cleaning much easier.

Perfecting motion



Our understanding of perfect motion

Blum turns the opening and closing of furniture into an experience that significantly increases the comfort of motion in the kitchen. Several thousand employees are continually working worldwide implementing our concept of perfect motion. Within this process, we place the needs of the kitchen user as the focus of our actions. We are only satisfied when the kitchen user is satisfied. All of our partners who participate in the furniture making process profit from this focus.

For over 50 years, quality has been the highest principle for the development and manufacture of our products. Our fittings systems shout "high quality" with their well-thought-out function, recognised design and high durability. They are designed to inspire and trigger fascination for perfect motion. We also set the bar very high for the services we offer. They must provide the best possible support to our partners.

So that we can target our efforts at all levels, we are in a constant dialogue with kitchen users and regularly exchange information with furniture manufacturers, joiners and distributors.





Julius Blum GmbH
Furniture Fittings Mfg.
6973 Höchst, Austria
Tel.: +43 5578 705-0
Fax: +43 5578 705-44
E-mail: info@blum.com
www.blum.com

The Blum logo, consisting of a stylized arrow pointing upwards and to the right, followed by the word 'blum' in a bold, lowercase, sans-serif font. A registered trademark symbol (®) is located at the top right of the word.

All content is copyrighted by Blum.
Subject to technical modifications and changes to the range without notice.
Printed in Austria · ID NO.: 729.363.4 · EP-172/1 EN-AL/06.10-1 LIGHTHOUSE.de